

# Chapter 5

## Stacking and Loading Lumber for Kiln Drying

Sorting	103
Species	103
Moisture content	104
Heartwood and sapwood	104
Wetwood	104
Grain	104
Grade	104
Thickness	105
Length	106
Sorters	106
Stickers	106
Sticker material	107
Moisture content of stickers	107
Sticker size	107
Width	107
Thickness	107
Load supports	107
Sticker location, spacing, and alignment	108
Location	108
Spacing	108
Alignment	109
Auxiliary stickers	109
Sticker guides	109
Care of stickers	110
Box piling random-length lumber	110
Mechanical stacking and unstacking equipment	110
Stackers	110
Unstackers	112
Stacking lumber for various types of dry kilns	112
Kiln samples	112
Kiln sample pockets built into stack	113
Kiln sample pockets cut into stack	113
Kiln samples in bolster space	113
Protecting stacked lumber	113
Weights and restraining devices	113
Loading and baffling dry kilns	114
Track-loaded kilns	115
Package-loaded kilns	116
Literature cited	116
Sources of additional information	116

Much of the degrade, waste, and moisture content variation that occurs during kiln drying results from poor stacking and loading. Well-stacked lumber and properly loaded and baffled kilns result in faster and more uniform drying, less warp, and less sticker loss. Stacking and loading procedures vary widely for hardwoods and softwoods, differences in plant layouts, type of material to be dried, and types of kilns and stacking equipment. However, certain principles apply to all stacking and loading. The purpose of this chapter is to describe these principles.

### Sorting

Sorting lumber before drying simplifies stacking and also aids in placing material of similar drying characteristics in the same kiln charge. The extent of sorting depends on practical considerations--some sorts are almost unavoidable, whereas others are sometimes omitted. Lumber can be sorted by species, moisture content, heartwood and sapwood, wetwood, grain, grade, thickness, and length.

### Species

Some species of wood have markedly different drying characteristics than others. For example, the time required to kiln dry green 4/4 red oak to a final moisture content of 7 percent is two to three times that required to kiln dry 4/4 hard maple. Furthermore, a milder drying schedule must be used for the oak to avoid drying defects. If these two species were dried in the same kiln charge, the hard maple would have to be dried by the milder oak schedule. Consequently, the hard maple would be in the kiln longer than necessary,

which increases drying costs. On the other hand, the drying characteristics of hard maple and yellow birch do not differ greatly. Thus, if the lumber has the same thickness and moisture content, these species can be dried together economically. Similarly, in softwoods the cedars and redwood might take three to five times as long to dry as Douglas-fir or the true firs. So, whenever possible and practical, a kiln charge should consist of the same species or of species with similar drying characteristics.

## Moisture Content

It is not desirable to mix air-dried, partially air-dried, and green lumber in the same kiln charge. Wetter lumber requires milder initial drying conditions and longer drying time than drier lumber. For example, 4/4 cypress air dried to a moisture content of 25 percent can be kiln dried to 7 percent moisture content in about one-half the time required to dry green lumber to the same final moisture content. Similarly, 4/4 red oak can be kiln dried from 25 to 7 percent moisture content in about one-quarter the time required to kiln dry red oak from green to 7 percent.

Because of the many variables involved, specific recommendations cannot be made as to the maximum allowable difference in initial moisture content between the driest and wettest lumber in a kiln charge. This difference must be determined by each kiln operator on the basis of production needs and the quality of drying desired. In general, the difference in moisture content between the driest and wettest lumber in a kiln charge should be smaller (1) for air-dried or partially air-dried lumber than for green lumber, (2) for shorter expected drying times than for longer times, and (3) for a narrow range in the desired final moisture content.

## Heartwood and Sapwood

In many hardwood species, sapwood has a higher green moisture content than heartwood (ch. 1, table 1-4). In addition, sapwood generally dries faster and has fewer defects than heartwood. Thus, sapwood and heartwood usually reach the final moisture content at different

times. Because of these differences, it would often be advantageous to separate heartwood from sapwood, but this is usually impractical.

## Wetwood

Wetwood, sinker stock, and wet pockets are terms used to describe wood that has a green moisture content higher than that of the normal wood of the species (see ch. 8 for additional discussion). The higher moisture content is sometimes confined to areas that are surrounded by normal wood. The condition is usually confined to heartwood, but also often occurs in the transition zone between sapwood and heartwood. In addition to higher green moisture content, wetwood usually dries considerably slower and often with more drying defects than normal wood of the species. The net result is that final moisture content after kiln drying is quite variable, and drying defects sometimes occur when wetwood and normal wood are kiln dried together. Some affected species are the hemlocks, true firs, aspen, oak, and cottonwood. For example, typical kiln-drying times to 19 percent moisture content for western hemlock dimension lumber are 78 h for normal heartwood (65 percent green moisture content), 115 h for sapwood (170 percent green moisture content), and 160 h for wetwood (145 percent green moisture content). Sorting techniques on the green chain, which transports lumber between the edger and the lumber stacker, are possible, but they are not always accurate or practical. Faster and more reliable techniques need to be developed for effective, practical sorts.

## Grain

Flatsawn lumber (ch. 1, fig. 1-6) generally dries faster than quartersawn lumber, but it is more susceptible to such drying defects as surface checks, end checks, and honeycomb. For practical purposes, large quantities of quartersawn lumber may be segregated from flatsawn lumber and dried under relatively severe kiln conditions, using a shortened drying time.

## Grade

The upper grades of lumber, both hardwood and softwood, are generally used in products that require higher strength, closer control of final moisture content, and better appearance than the lower grades. Therefore, higher grade lumber is usually sorted out and kiln dried by different schedules than the lower grades.



## Thickness

Sorting for thickness is essential. Uniform thickness of lumber simplifies stacking and drying. It also reduces warping in the lumber as well as breakage and distortion of stickers. Warping of lumber and sticker distortion resulting from stacking lumber with different thicknesses are shown in figure 5-1a. Cupping and twisting in the thinner boards is caused by lack of contact between the boards and stickers. Without the restraint of the weight of the lumber pile, boards are very likely to warp. Warping and distortion also disrupt airflow through the lumber pile, resulting in nonuniform drying. A stack of uniformly thick and well-piled lumber is shown in figure 5-1b.

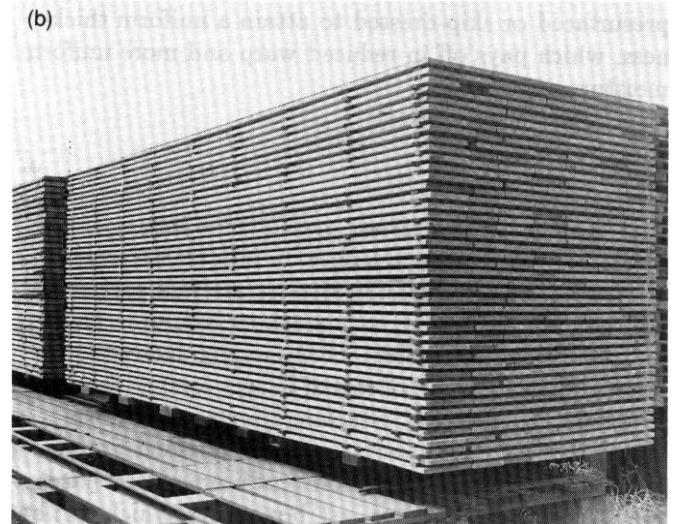

Figure 5-1—(a) Stacking lumber of different thicknesses in the same stack results in warping of lumber and deformation and breakage of stickers. (b) Lumber of uniform thickness and stickers remain flat during drying. (M 115549, M87 929)

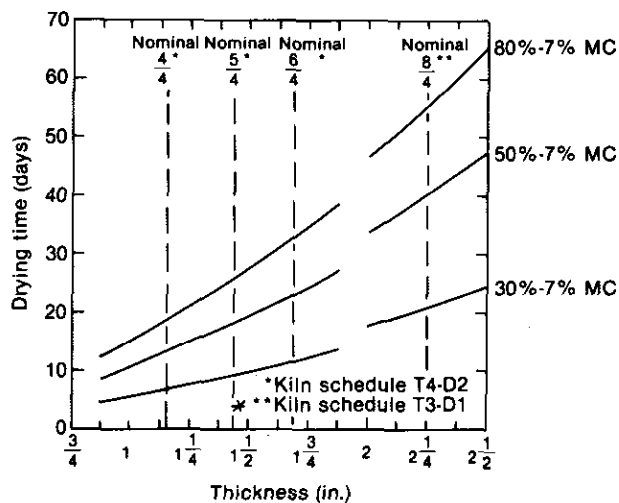

Figure 5-2—Effect of thickness and initial moisture content on kiln-drying time of red oak. (ML88 5562)

Another reason for sorting for thickness is the variation in drying time with thickness. Figure 5-2 shows the effect of thickness on kiln-drying time of red oak. For example, kiln drying from green to 7 percent moisture content might range from 18 days for 4/4 lumber to 32 days for 6/4 lumber to 55 days for 8/4 lumber.

Lumber that is miscal is likely to vary considerably in thickness across the width and along the length of the piece. Not only is miscal lumber difficult to stack, the thinner part of boards cannot be kept flat. Moreover, the thicker parts dry more slowly and may develop more defects than thinner parts. Lumber is sometimes presurfaced or skip-dressed to attain a uniform thickness, which pays off in reduced warp and more uniform moisture content.

## Length

One of the best and easiest methods for sorting is to stack lumber of a single length on kiln trucks or in packages (fig. 5-1b). If the stickers are well supported and in good alignment, such stacking results in flatter and straighter lumber. Overhanging ends of longer boards in a truckload of mixed-length lumber are likely to warp during drying. Stacking lumber of uniform length is a common practice among softwood producers and some larger hardwood producers. Most hardwood producers, however, use box piling, which will be described later in this chapter.

## Sorters

Lumber is often sorted by grade and size on the green chain between the edging and stacking operations. Different categories of boards are held in bin or sling sorters until the lumber is stacked for drying. Different types of sorters are the slant bin, vertical bin, sling, and buggy. A sling and a slant-bin sorter are shown in figure 5-3.

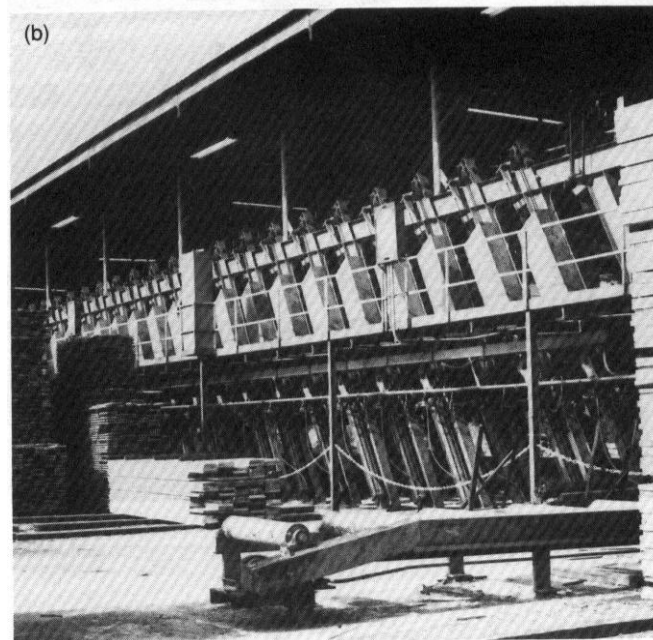
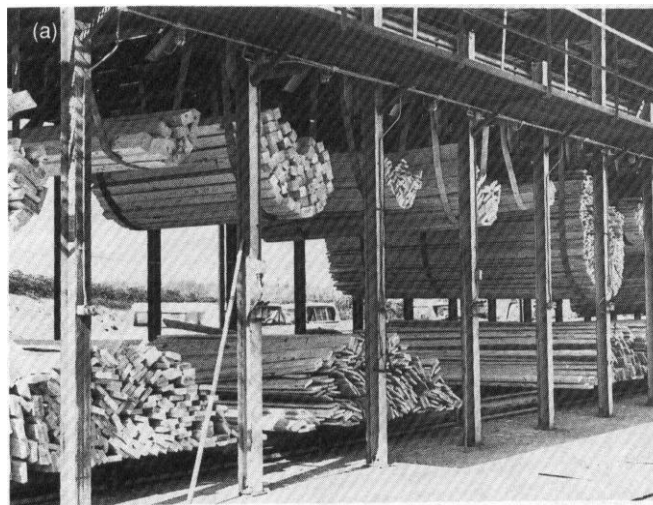

Figure 5-3—Sling sorter (a) and slant-bin sorter (b) for holding sorted lumber prior to stacking for the dry kiln. (MC88 9029, MC88 9031)

## Sticker Lumber

The purpose of stickers is to separate each board surface so that air can flow over each surface and evaporate water. Stickers must be selected and placed so that they give adequate support to minimize warping of the lumber and breakage and distortion of stickers. In most applications, stickers should also be chosen to minimize stains that sometimes develop in the lumber that contacts the stickers. Important considerations of stickering include species and grade of wood used for stickers, moisture content of stickers, sticker size and placement in stack, and load supports.

## Sticker Material

Many stickers are required in a kiln-drying operation, and replacement is costly. Practical measures for lengthening sticker life are therefore worthwhile. Stickers are often made from clear, straight-grained lumber rather than from low-grade lumber. The initial cost of such stickers may be higher, but their longer service life usually offsets this cost. Straight-grained stickers made from the harder woods stay straighter, break less, and generally last longer than irregular-grained stickers from softer woods.

Species such as hickory, hard maple, beech, oak, Douglas-fir, and larch make good stickers. However, for practical reasons, the species being dried at the plant are usually used for stickers.

## Moisture Content of Stickers

Stickers should be made from kiln-dried lumber. They should be protected from reabsorbing moisture during storage or holding between kiln charges. This reduces the chance of sticker stain, which is a discoloration on the surface of or deeper within the lumber where it contacts the sticker. Kiln drying the stickers kills mold spores that cause the stain, and protection from reabsorption minimizes pickup of new spores. The use of heartwood for stickers also reduces staining. In addition, kiln drying reduces the distortion and thickness shrinkage of stickers that could occur in use.

## Sticker Size

### Width

Wide stickers slow the drying of lumber in the areas of contact; these areas may remain at a higher moisture content than areas of the lumber not in contact with the stickers. If stickers are too narrow, the lumber or stickers are liable to be crushed. Stickers for hardwoods are usually 1-1/4 to 1-1/2 in wide and should not exceed 1-1/2 in. Stickers for softwoods are generally about 2 in wide and sometimes up to 3 in wide for softer species such as sugar, white, and ponderosa pine.

### Thickness

Stickers are usually 3/4 to 1 in thick, although 1/2-in-thick stickers are sometimes used. The thinner stickers increase the capacity of a kiln and may be adequate for slow-drying species. They increase air velocity through the lumber stack and tend to make airflow more uniform. However, the increased number of layers of boards in a kiln causes a decrease in the volume of air passing over each board face. In fast-drying species, the volume of air per unit time may be inadequate

to hold the amount of moisture evaporating from the board surfaces. In some species, such as eastern white pine, this lower evaporation rate may cause staining of the surface. In addition, thinner stickers break and deform more readily, and sagging boards are likely to obstruct airflow.

Regardless of size of thickness, all stickers within a kiln charge should be surfaced to a uniform thickness. Thickness and width should be sufficiently different to avoid sticker misorientation (for example, a sticker placed on edge rather than flat).

## Load Supports

Unless lumber stacks are properly supported, sagging and distortion in the lower courses will result (fig. 5-4a). On the other hand, lumber stacked as in figure 5-4b will not sag because the load supports are directly under tiers of stickers. The schematic in figure 5-5 shows the proper alignment of load supports and stickers.

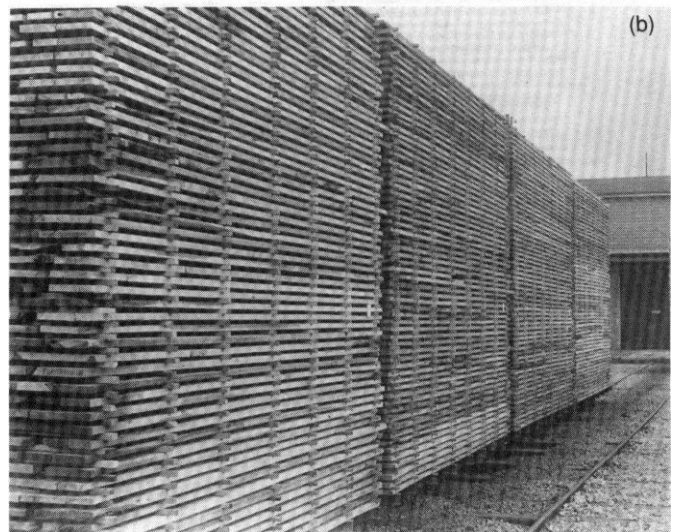
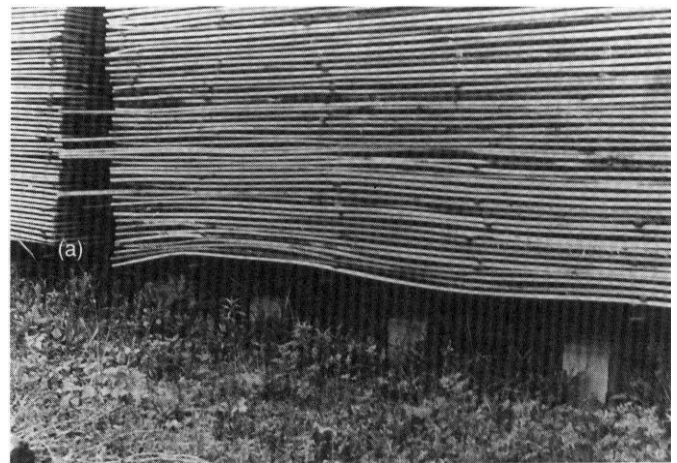

Figure 5-4—(a) An insufficient number of load supports, improperly placed, causes sagging in this stack of lumber. (b) Properly aligned load supports prevent sagging of the stack and distortion of the lumber. (M 115545, M 115696)

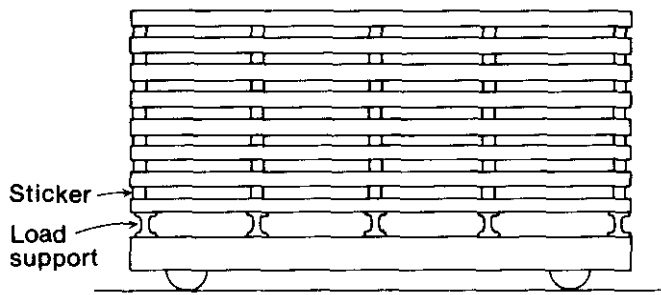

Figure 5-5—Typical lumber truck showing alignment of load supports and stickers. (ML88 5566)

The thinner the lumber, the greater the number of load supports required. A bottom course of thick dunnage sometimes can be used instead of additional supports. The usual spacing for load supports is 2 ft. The distance between load supports can be increased for thick lumber, but it is better to use too many than too few supports.

## Sticker Location, Spacing, and Alignment

Good location, spacing, and alignment of stickers reduce warping and minimize end checking and splitting.

### Location

Stickers should be placed flush with or very near the ends of boards whenever possible (fig. 5-5). This will minimize warping at the ends of boards and will also retard end drying to some extent, thus helping to minimize end checking and splitting.

### Spacing

Optimum sticker spacing is governed by the lumber's tendency to warp, its thickness, and its resistance to crushing. In general, hardwoods require closer sticker spacing than softwoods. Some particularly warp-prone species like sweetgum and the elms benefit by spacing of less than 2 ft. The stickers of hardwoods that are thinner than 1 in should also be spaced less than 2 ft apart. Also, to avoid crushing stickers between the bottom courses of heavy loads, sticker spacing may need



Figure 5-6—Package of lumber raised by forklift truck. Short tiers of stickers above point of contact with forks reduce sag in the lower courses of lumber and help

prevent the end stickers from falling out of the stack, (M 115553)

to be reduced. Modern lumber-stacking machines typically have sticker guides adjustable in 1-ft increments. However, these machines are commonly operated with the guides set for 2-ft sticker spacing for both hardwoods and softwoods.

### Alignment

For the best control of warp during drying, the tiers of stickers should be aligned vertically (figs. 5-4b and 5-5). Misaligned stickers (fig. 5-4a), particularly in stacks of green lumber, invariably cause nonuniform distribution of weight and result in sharp kinks in the lumber where the stickers contact it. The thinner the lumber, the greater the possibility of kinking. Considerable waste results from incorrectly aligned stickers in 4/4 lumber.

### Auxiliary Stickers

Packages of lumber are commonly transported around dry kilns with forklift trucks and straddle carriers. When lifted by this kind of equipment, lumber in the lower courses of a package often sags, and stickers at the ends may fall out. One way to avoid this problem is to use short tiers of stickers above the forks (fig. 5-6) or the carrier bunks. The number of stickers needed in these extra tiers depends upon the thickness of the lumber and the weight of the package. Usually stickers are interlaid between the bottom 6 to 10 courses of lumber.

### Sticker Guides

Sticker guides are devices that force stickers to be placed in exactly the same vertical alignment tier after tier. They ensure good spacing and alignment of stickers and are used almost universally. Sticker guides vary in type and are used in both manual and automatic stacking. One type used in manual stacking is shown in figure 5-7. Vertical channel irons equal in length to the height of the load are positioned along each guide at points corresponding to the desired sticker spacing. The stickers, cut about 2 in longer than the desired width of the load, are held in place by the guide channels.

Semiautomatic stackers have built-in sticker guides (figs. 5-8, 5-9). They are similar to the guide described above except that they do not need to be as tall as the stack because the level of the top course changes as the stack is built, and there is no need to pivot the guide away from the stack. Most plants use semiautomatic or automatic stackers.



Figure 5-7—Sticker guides for stacking lumber on kiln trucks. (M 134969)

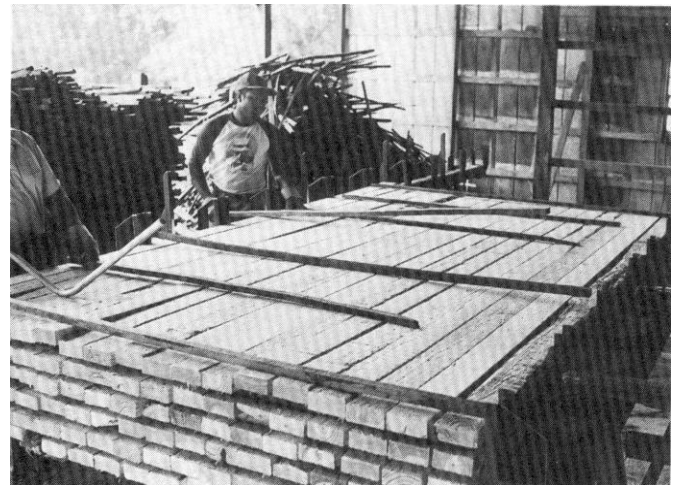

Figure 5-8—Semiautomatic stacker. Lumber stack is located on hydraulic lift so that the level of the top course is always at working level for the sticker crew. Stickers are placed by hand. (MC88 9013)

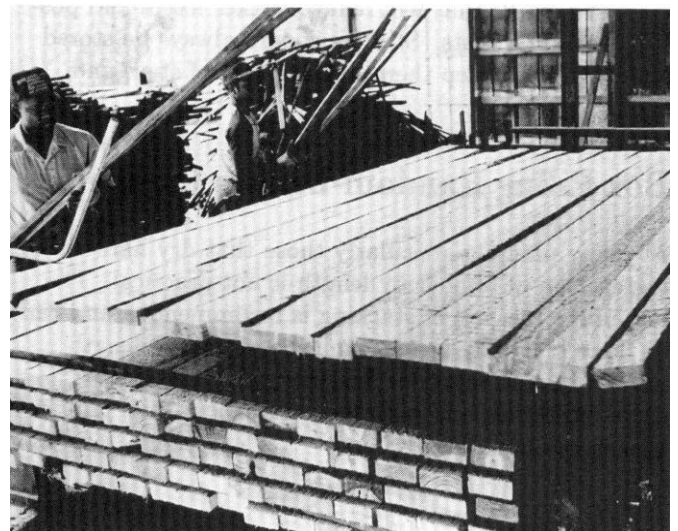

Figure 5-9—Semiautomatic stacker. Lumber stack is located on hydraulic lift so that the level of the top course is always at working level for the sticker crew. Stacker arm moves course to a position over stickers and lowers it into position. (MC88 9012)

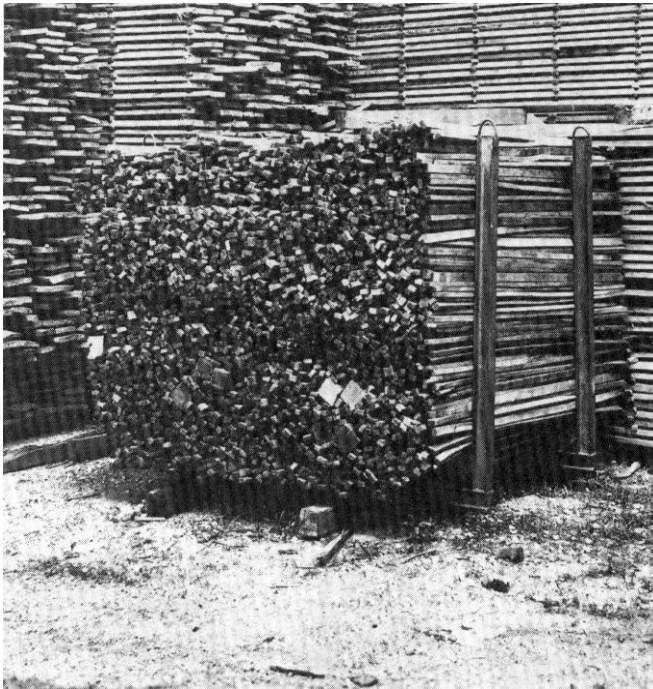

Figure 5-10—The handling of stickers is facilitated if they are racked for transport by carrier or forklift truck. (MC88 9011)

### Care of Stickers

The primary concerns in the care of stickers are to prevent breakage in handling, distortion in handling or storage, and excessive pickup of water in storage that could support the growth of molds that could cause stain. Large plants often invest considerable money in sticker-handling equipment, such as conveyors, to reduce handling costs without damaging the stickers. Smaller plants can construct racks or other holding devices (fig. 5-10) that will reduce sticker losses and possibly handling costs. Stickers should always be stored under cover to keep them dry and free of stain and decay.

### Box Piling Random-Length Lumber

At many plants, particularly those that dry hardwoods, segregation of lumber by length is not practical. The box-piling method of stacking is recommended and can be done manually or mechanically. Random-length lumber that is box piled will dry straighter, flatter, more uniformly, and with less sticker loss than lumber that is not box piled.

In box piling, the length of the outside boards in each course is equal to the full length of the stack. Thus, in figure 5-11, boards numbered 1 and 7 in all courses are as long as the stack. Other full-length boards, when available, are usually placed near the center of the courses, such as board 4 in course A and B. The shorter boards in the same course are alternately placed with one end even with one or the other end of the load. The shorter boards in all courses in the same tier of boards are all placed with one end even with the same end of the load. For example, in figure 5-11 all even-numbered short boards (with the exception of board 6, course D) are placed even with the front end of the load and all odd-numbered boards even with the rear end. Occasionally, two narrow, short boards, such as boards 5 and 6 of course D, are placed over a wider board, such as board 5 of course C. Also, two or more short boards can sometimes be laid end to end in the same tier of lumber. For example, 6- and 8-ft boards could be laid end to end in a load of lumber 14 to 16 ft long.

The column effect obtained by box piling ensues that all boards are well supported and held down; warp, particularly cup and bow, is thereby lessened, along with sticker deformation and breakage. The unsupported ends of the short boards within the stack may warp to some extent.

If enough full-length boards are not available for placement on the sides of the load in occasional courses, shorter boards laid end to end can be used. When this is done, filler blocks should be placed in any gaps between the stickers above and below the course of lumber, particularly when the gaps occur at the ends of the load. These blocks will keep the ends and sides of the loads from sagging and will also reduce sticker breakage. The blocks should be the same thickness as the lumber.

### Mechanical Stacking and Unstacking Equipment

Most plants use semiautomatic and automatic equipment for stacking and unstacking lumber. Several types of equipment are available, and they all eliminate any manual handling of lumber.

#### Stackers

With both semiautomatic and automatic stackers, a solid package of lumber is placed on a tilting breakdown hoist from which the lumber slides onto a conveyor where the courses are assembled. The stacked lumber, in some cases on the kiln trucks, is placed on a hydraulic lift controlled by the stacker crew and el-



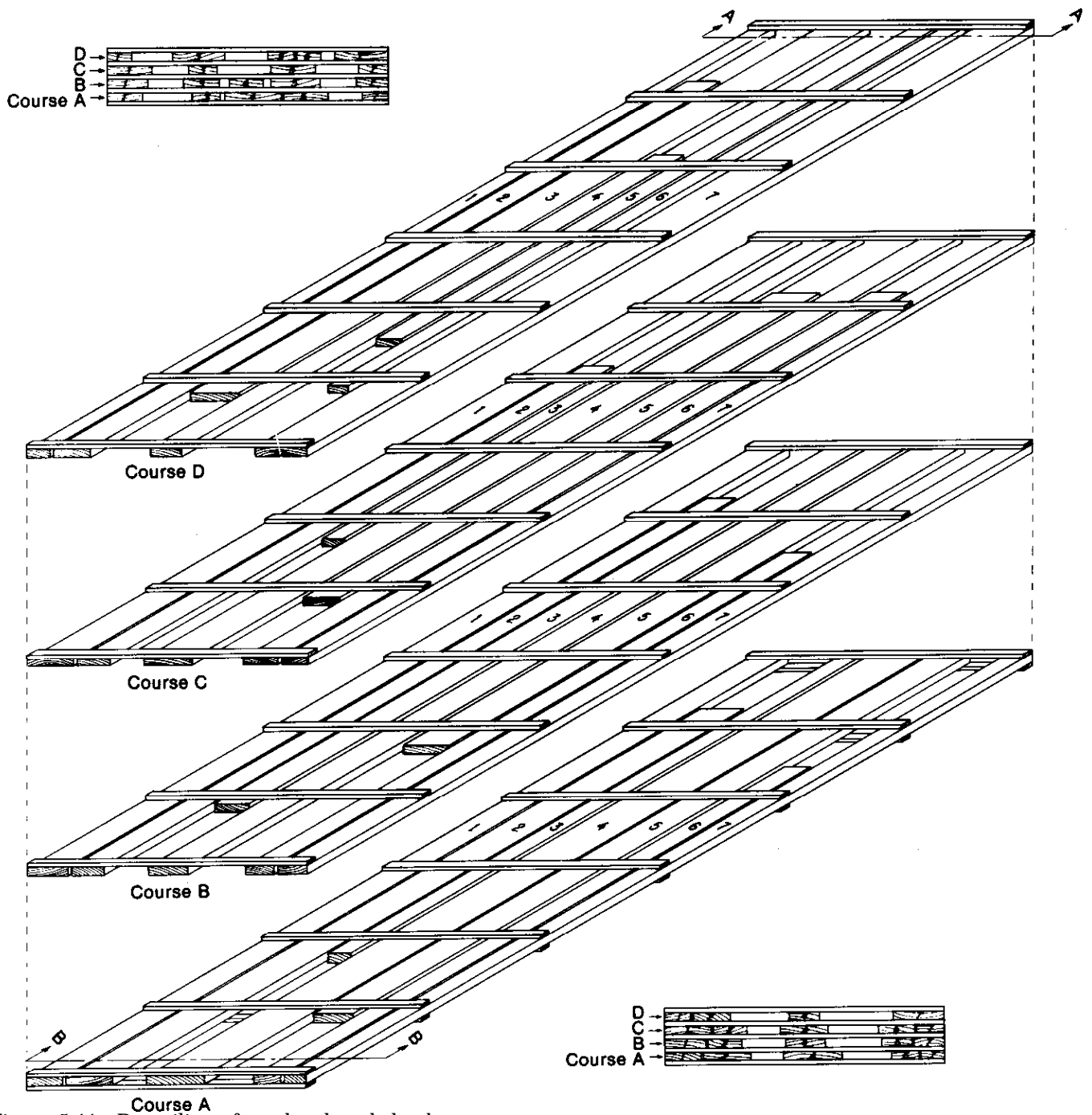

Course A  
 Figure 5-11—Box piling of random-length lumber.  
 (ML88 5565)

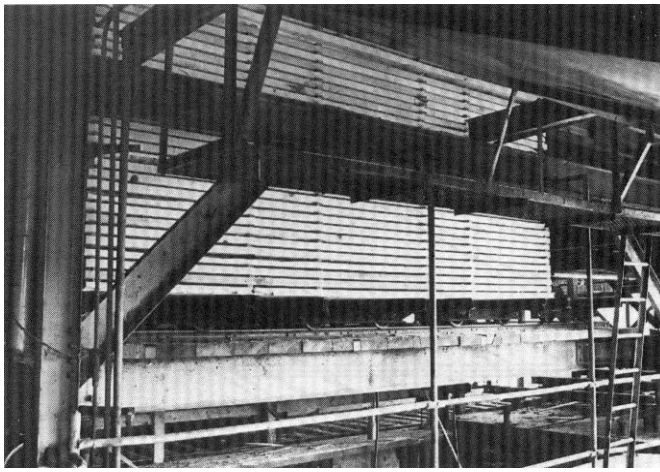

Figure 5-12—Lumber stacker showing hydraulic lift that keeps the top of the stack at working height. (MC688 9010)

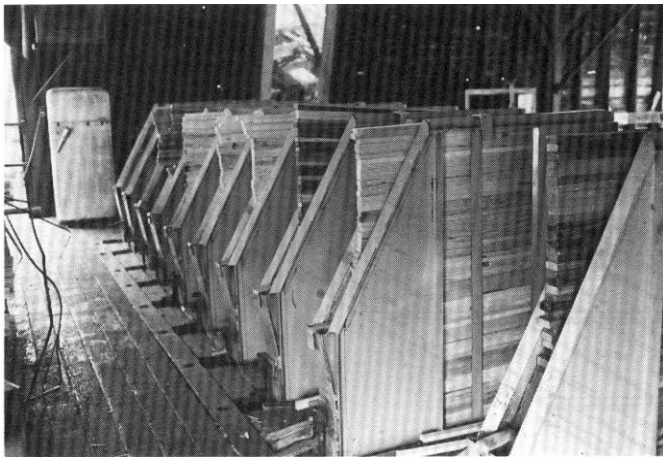

Figure 5-13—Sticker magazines located above automatic lumber stacker. (MC88 9009)

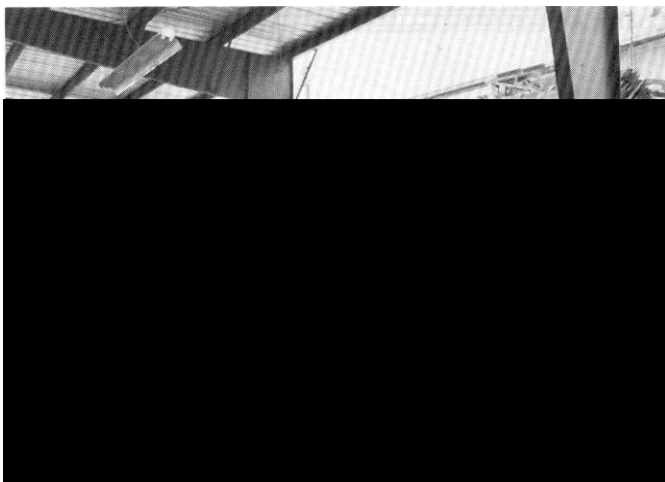

Figure 5-14—Lumber unstacker showing boards sliding onto a conveyor and stickers sliding away from the lumber. (MC88 9008)

evated to a comfortable working height (fig. 5-12). As courses of lumber are mechanically moved onto the lift, the load is lowered a distance equal to the thickness of the boards, stickers are placed, and another course of lumber is moved into position.

Semiautomatic stackers require that each sticker be placed by hand (figs. 5-8, 5-9). A stationary guide located on the lift facilitates alignment of the stickers. In automatic stackers, the stickers are typically loaded in a set of magazines located above the load of lumber on the lift (fig. 5-13). The stickers are positioned automatically on the course of lumber.

### Unstackers

With one common type of unstacker, the load of dried lumber is placed on a tilting hydraulic lift (fig. 5-14). The lift is raised and tilted, and the top course of lumber slides by gravity to the dry chain. The stickers slide down a ramp to a sticker bin or conveyor. The lift is then raised to the next course of lumber and the cycle repeated.

### Stacking Lumber for Various Types of Dry Kilns

Modern dry kilns are almost universally internal fan kilns where airflow is across the width of the lumber stack. In the past, there were other types of kilns, such as natural circulation and external blower kilns and kilns where air flowed along the length of the stacks or sometimes even vertically. For optimum airflow, stacking procedures had to conform to the type of kiln used. Since few of these older type kilns remain in service, stacking procedures for them will not be discussed here. The earlier version of this manual (Rasmussen 1961) contains these stacking procedures.

### Kiln Samples

Kiln samples, that is, boards used to estimate the progress of drying, will be described in detail in chapter 6. Although other process-control techniques are beginning to be applied, the use of sample boards is still widespread in hardwood kiln drying. Moreover, some of the newer automatic kiln-control schemes still depend on the selection and placement of kiln samples.

Kiln samples are placed in the lumber stack in one of three possible ways: (1) kiln sample pockets are built into the stack, (2) kiln sample pockets are cut into the stack, and (3) kiln samples are placed in the bolster space.

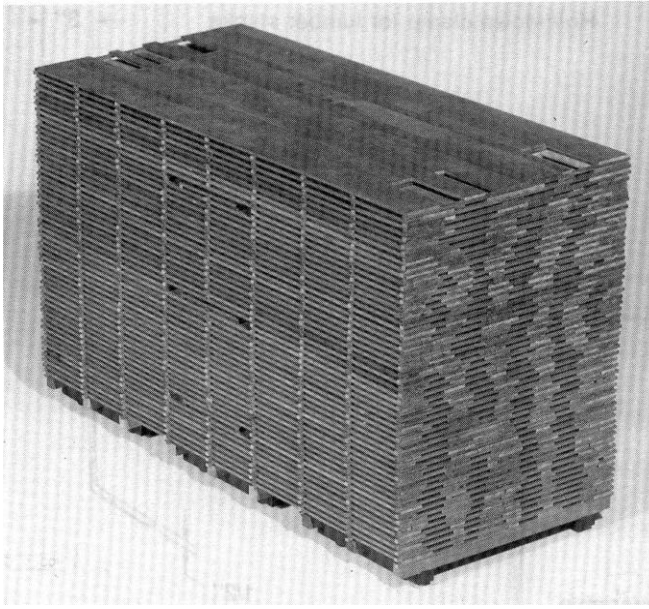

Figure 5-15—Box piling of random-length lumber showing sample pockets and kiln samples. (M 75804)

### Kiln Sample Pockets Built Into Stack

Ideally, kiln samples are placed in pockets in the lumber stacks (fig. 5-15). These pockets can be built in at the time of stacking. Since the kiln samples are usually longer than the space between tiers of stickers, the sticker or stickers immediately above the sample should be shortened by the width of the kiln sample. Otherwise, these stickers will bear on the sample and make it impossible to remove the sample for periodic weighing and examination. Two short stickers, the width of the sample pocket, are used to support the kiln sample and allow air circulation across both faces.

### Kiln Sample Pockets Cut Into Stack

If it is not feasible to make kiln sample pockets at the stacker, the kiln operator can create sample pockets after stacking. If appropriate safety precautions are taken, kiln samples can be cut from stacked lumber with a small chain saw. Care is necessary because the small space requires cutting with the tip of the saw, which can cause kickback of the blade. Guides can be attached to the saw bar to help steady the blade and prevent cutting adjacent boards. Unfortunately, the recommended length of kiln samples is greater than normal sticker spacing. Removing the cut kiln sample from the stack is relatively easy if the sample is shorter than the sticker spacing because there are no stickers above and below the sample to hold it in place. However, when the sample is longer than the sticker spacing, there will be one point on the sample where it is held in place above and below by stickers. In this situation, it is necessary to pry or jack up the board above the sample to relieve the sticker pressure and remove

the sample. A simple forklike tool can be fitted over the end of the sticker that is left when the sample is removed; the end of the sticker can be snapped off with a sideways motion of the tool.

### Kiln Samples in Bolster Space

A shortcut taken by some kiln operators is to place kiln samples in the bolster space between packages of lumber in package-loaded kilns. This avoids the necessity of making pockets at the stacker or cutting them into the stack. However, airflow through the bolster space is not the same as airflow through the lumber stack, and the drying rate of kiln samples placed there is not representative of lumber in the stack. Holding racks for samples can be made with boards above and below the sample, thus simulating a sample pocket, but the samples are not at the same moisture content as boards in the stack, which will affect their drying rate somewhat. Kiln operators who have placed kiln samples in the bolster space successfully have carefully correlated the drying rate of the samples with the drying rate of lumber in the stack. These samples dry a little faster than they would if properly placed in the stack, and the operators adjust kiln conditions accordingly. Particular care must be taken if the lumber is at a high moisture content upon entering the kiln. In this case, airflow is particularly important in determining drying rate, and disastrous errors in estimating moisture content of the lumber in the stack are possible. When the lumber entering the kiln has been air-dried or predried to 25 percent moisture content or below, airflow becomes less important in determining drying rate, and fewer errors result from using samples in the bolster space to estimate moisture content of lumber in the stack.

### Protecting Stacked Lumber

Kiln trucks or packages of lumber stacked for kiln drying are often air dried first or held at the loading end of the kiln for some period of time before entering the kiln. Such lumber should be protected from rain and direct sunshine to prevent checking and warping of the upper layers. Portable roofs made of simple building materials, such as corrugated metal, can be used for this purpose (fig. 5-16). An open shed or roof over the green end of the kiln is also an effective means of protection.

### Weights and Restraining Devices

Weights placed on top of a load of lumber or restraining devices that exert pressure are frequently used to reduce warp in the top layers of a stack. Concrete slabs are often used for top weighting, and at least 50 lb/ft<sup>2</sup> is necessary for effectiveness. Top loading has been found effective in reducing bow and twist, but less so

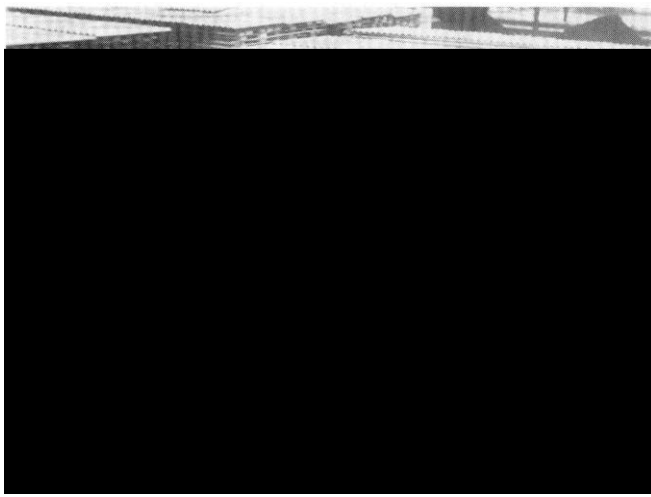

Figure 5-16—Corrugated pile covers for kiln trucks of lumber stored outdoors prior to kiln drying. (M 115539)

in reducing crook. Serrated or pinned stickers (stickers with metal pins that protrude vertically along the length of the sticker and are spaced a little further apart than the width of board) have been found effective against crook in laboratory experiments, but have not been used commercially.

Spring-loaded clamps are also used to reduce warp in top layers (fig. 5-17). One common device consists of wire rope and tension springs attached to each end of light I-beams that extend across the load directly over the stickers and about 6 in beyond each edge. The spring is pulled into tension and hooked into a sticker opening about 5 to 6 ft below the top of the load. The spring extension usually accommodates the load shrinkage, but it sometimes requires adjustment during drying.

## Loading and Baffling Dry Kilns

Overloading and underloading affect the quality of drying achieved in a given kiln. A capacity load assumes not only that the lumber is properly stacked in the kiln but also that the loads or packages of lumber are of lengths that provide suitable overall dimensions. That is, the spaces between truckloads and between the charge and walls and ceiling are those called for by the kiln design. If these spaces are changed by overloading or underloading, air circulation is changed as well, with consequent effects on drying time and quality.

The higher the air velocity in a kiln, the greater the possibility that air will short circuit through gaps. The basic principle of airflow through lumber in a kiln is that the fans cause air pressure to build up in the plenum chamber on one side of the load. This static pressure causes airflow through the load; ideally the

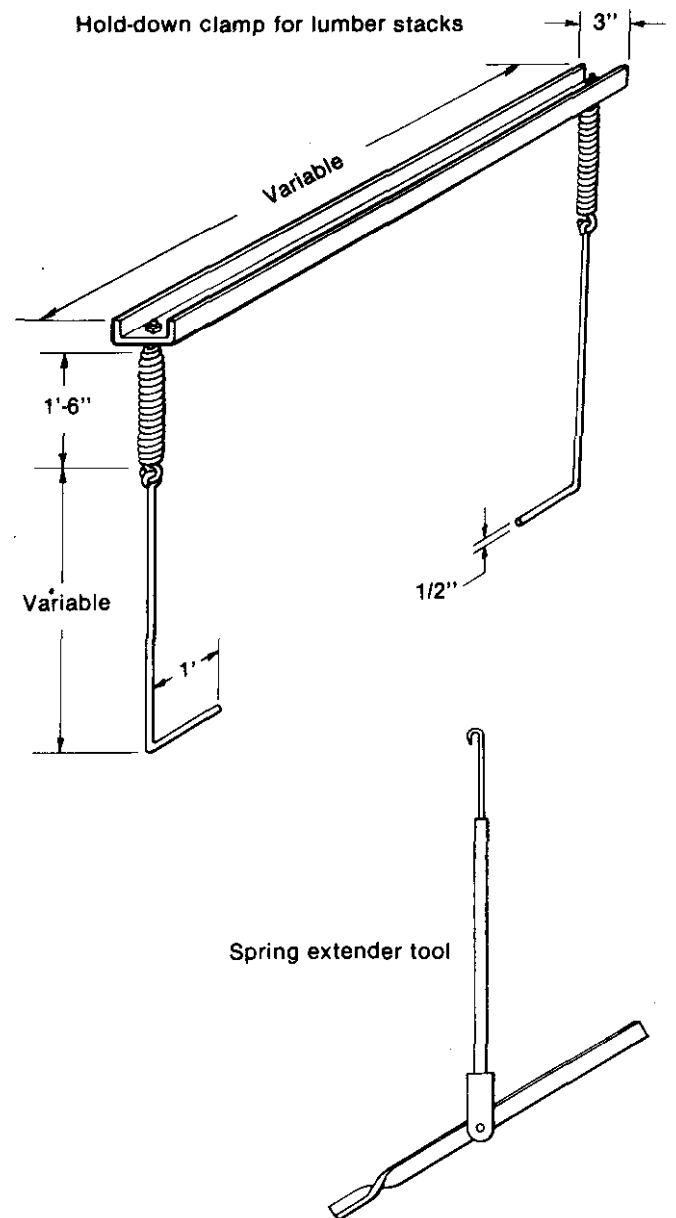

Figure 5-17—Spring-loaded hold-down clamp for reducing warp in top layers of lumber and spring extender tool. (ML88 5564)

pressure is uniform, so that airflow is also uniform. Any gaps in, around, over, or under the load provide flow paths for air and prevent the buildup of uniform air pressure. Kilns are usually engineered with specific fan characteristics and plenum chambers, and they should not be altered without careful consideration.

Although a particular dry kiln is not limited to only certain lengths of lumber, a kiln operator must consider how overloading or underloading affect air circulation and thus plan the loading patterns to the best advantage, deviating as little as possible from the overall charge dimensions best suited for the kiln. When circumstances demand that the loading pattern must be

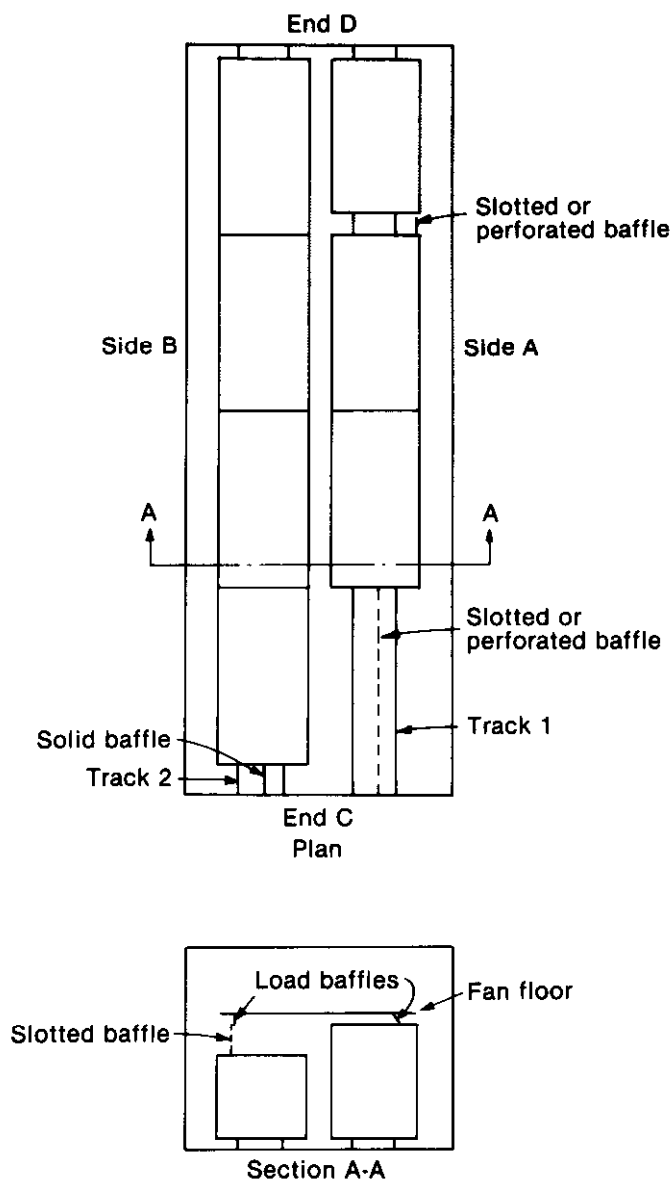

Figure 5-18—A method of baffling voids in a charge of lumber in a double-track kiln. (ML88 5563)

considerably changed from the norm, the kiln operator should exercise special care to keep air circulation as uniform as possible by adding auxiliary load baffles.

### Track-Loaded Kilns

In single-track kilns, the distance between the loads of lumber and top load baffles should not exceed 4 in. The ends of the kiln trucks of lumber should be butted snugly together. If this is not possible because long boards overhang from the ends of the loads, the voids created should be blocked. If the kiln charge lacks one or more lumber trucks, the entire charge should be pushed to one end of the kiln, and the empty area should be closed by solid baffles extending from the track level to the kiln ceiling, the fan floor, or the top load baffle. If the kiln has doors on one end only, a

charge that is short one or more kiln trucks should be pushed toward the closed end rather than the door end of the kiln.

More care is required in loading multiple-track kilns (ch. 2, fig. 2-2) than single-track kilns with the same type of loading. Short circuiting through voids in a charge of lumber in a single-track kiln can be controlled with solid baffles. In a multiple-track kiln, however, a solid baffle blocking a space in one track of lumber may reduce airflow through some of the lumber on the other tracks.

A method of baffling voids in a double-track kiln is illustrated in figure 5-18. Track 1 has three trucks of lumber, one of which is a short load, and track 2 is fully loaded. The void spaces on both tracks between kiln-end D and the loads are small, about 1 ft wide. A temporary solid baffle extending from the kiln floor to the fan floor can be installed in this opening if desired, but since the opening is quite small, the value of a baffle here is questionable. The larger voids between the short and long loads on track 1 and between kiln-end C and the ends of the loads are blocked off by temporary baffles to prevent excessive short circuiting of the air. The baffles shown on track 1, however, should not be solid. A solid baffle here would block off track 2 from air circulating through the loads from side A to side B, and the lumber on this track would be shorted of air and dry more slowly than the rest of the charge. Slotted or perforated plywood baffles have been used in a situation like this. Snow fence has also been used successfully. Perforated baffles do not provide the same resistance to airflow as a load of lumber, but they reduce short circuiting considerably. The space on kiln-end C, track 2, is blocked off with a temporary solid baffle.

The low load illustrated on track 2 (section A-A) would produce a large void that would permit excessive short circuiting of air if it were not baffled. The slotted or perforated baffle shown between the load baffle and the top of the low load permits air to move across the loads on both tracks in both directions of airflow with very little short circuiting.

If a charge in a double-track kiln is short two lumber trucks, each track should be loaded one truck short. The trucks should be butted together. Both tracks should be loaded as closely as possible to the same end of the kiln so that most space occurs at the opposite end. Then, with both tracks evenly loaded, two solid, temporary baffles can be placed to block out the space on each track.

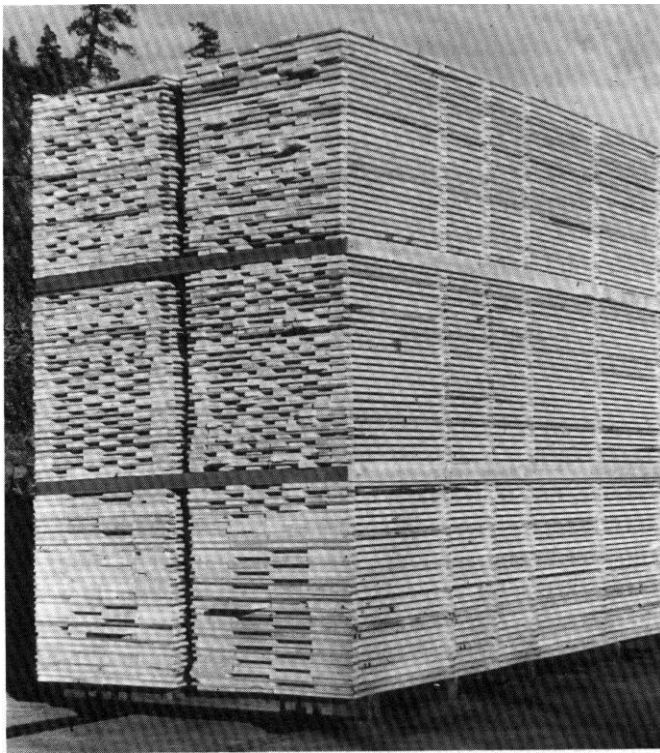

Figure 5-19—Packages of lumber properly spaced side by side on kiln trucks for kiln drying. (M 100902)

Sometimes lumber is stacked in packages, and the packages are loaded by forklift and placed two-wide on kiln trucks (fig. 5-19). The sides of adjacent packages should be spaced 3 to 4 in apart. If this is not done, the sticker openings between courses of lumber may not line up as drying progresses because of nonuniform shrinkage between loads. When this happens, the circulating air may be blocked off. Note also in figure 5-19 that strips of lumber are fastened to the ends of the bolsters separating packages. This practice is recommended because large volumes of air can short circuit through these openings, which are usually 4 in wide.

### Package-Loaded Kilns

Careful placement of packages and baffles is particularly important in package-loaded kilns (fig. 2-6) to prevent short circuiting of airflow. Short circuiting is more critical in this type of kiln than in track-loaded kilns because of the generally longer distance air must travel from the entering-air to the leaving-air side of the load. In general, the greater the capacity of package-loaded kilns, the more difficult it is to prevent short circuiting. When loading a package kiln, the initial back row of packages should be placed tight against one wall. The second row should be “side-shifted” so it is tight against the opposite wall. The placement of packages should be alternated from one wall to the other until all rows have been loaded. This will leave a minimum of air space along either wall for short circuiting of air.

Kiln operators are sometimes tempted to add an extra tier of packages to increase the kiln capacity. This narrows the plenum space from the design width and causes nonuniform airflow through the load. It is poor practice and not recommended.

The spaces between adjacent tiers of packages are sometimes made smaller or larger than recommended. If the spaces are too small, circulation through the sticker openings may be impaired because the openings are misaligned during load shrinkage. If the spaces are too large, air will short circuit through the openings or around the ends of the tiers of packages.

The installation of additional top- and side-load baffles reduces short circuiting over or around the ends of the tiers of packages and increases kiln efficiency. Temporary solid or slotted baffles may be required when large voids occur in a kiln charge that is short one or more packages or in which the tiers of packages are incomplete. Solid baffles should never be placed so that they block airflow to any packages.

Because air generally travels a long distance across a charge of lumber in package-loaded kilns, blocking the bolster space (fig. 5-19) helps to prevent the short circuiting of air through the bolster space.

### Literature Cited

Rasmussen, E.F. 1961. Dry kiln operator's manual. Agric. Handb. 188. Washington, DC: U.S. Department of Agriculture. 197 p.

### Sources of Additional Information

**Angevine, A.** 1970. A tool system for cutting kiln samples from stickered lumber. Forest Products Research Society News Digest, Wood Drying Division. 4 p.

**McMillen J. M.; Wengert, E. M.** 1978. Drying eastern hardwood lumber. Agric. Handb. 528. Washington, DC: U.S. Department of Agriculture. 104 p.

**Reitz, R. C.; Page, R. H.** 1971. Air drying of lumber. Agric. Handb. 402. Washington, DC: U.S. Department of Agriculture. 110 p.

**Ward, J. C.; Pong, W. Y.** 1980. Wetwood in trees: a timber resource problem. Gen. Tech. Rep. PNW-112. Portland, OR: U.S. Department of Agriculture, Forest Service, Pacific Northwest Forest and Range Experiment Station. 56 p.